

Accessories

Outlet Covers

3011

Cover for single pipe outlet

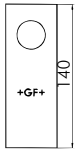

| d | Code | £ | SP | g | | | | | | | | | | | |
|-------|-------------|------|----|----|--|--|--|--|--|--|--|--|--|--|--|
| 16/20 | 760 856 008 | 0.65 | 10 | 40 | | | | | | | | | | | |

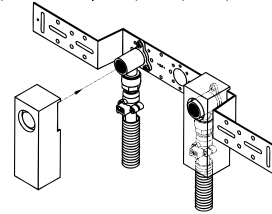

3012

Cover for dual pipe outlet

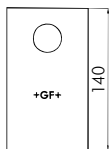
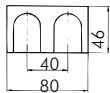

| d | Code | £ | SP | g | | | | | | | | | | | |
|-------|-------------|------|----|----|--|--|--|--|--|--|--|--|--|--|--|
| 16/20 | 760 856 009 | 0.71 | 10 | 50 | | | | | | | | | | | |

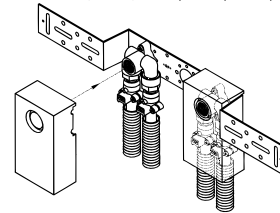

Mounting Plates

3102

Distance plate for dry lined walls - for supporting single & dual pipe outlets

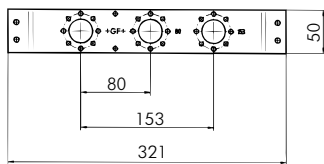

*Available on 2 week delivery

| | Code | £ | SP | g | | | | L | A | B | | | | | |
|--------|--------------|------|----|-----|--|--|--------|-----|----|-----|--|--|--|--|--|
| triple | *760 869 921 | 4.74 | 10 | 350 | | | triple | 321 | 80 | 153 | | | | | |

3154/3155 3168

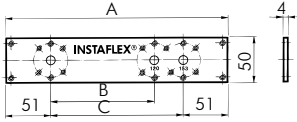

*Available on 2 week delivery

Distance plate for single and dual pipe outlet

| | Code | £ | SP | g | | | A | B/C | D | | | | |
|-------|-------------|------|----|-----|--|--|-----|----------|----|--|--|--|--|
| *3154 | 760 853 722 | 3.13 | 5 | 285 | | | 202 | 76.5/100 | 10 | | | | |
| *3155 | 760 853 723 | 3.37 | 10 | 365 | | | 255 | 120/153 | 10 | | | | |
| *3168 | 760 869 907 | 4.38 | 10 | 360 | | | 255 | 120/153 | 29 | | | | |

3156

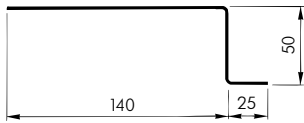
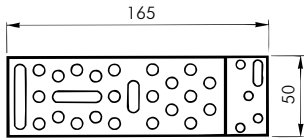

*Available on 2 week delivery

Angular support plate including screws

| | Code | £ | SP | g | | | | | | | | | |
|--|--------------|------|--------|-----|--|--|--|--|--|--|--|--|--|
| | *760 853 080 | 1.30 | 10 Set | 135 | | | | | | | | | |

3157

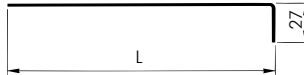
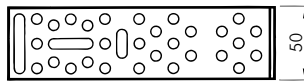

*Available on 2 week delivery

In front of wall angular support plate

including screws

| | Code | £ | SP | g | | | L | | | | | | |
|--|--------------|------|--------|-----|--|--|-----|--|--|--|--|--|--|
| | *760 853 070 | 1.30 | 10 Set | 145 | | | 187 | | | | | | |
| | *760 854 683 | 3.08 | 10 Set | 300 | | | 350 | | | | | | |

3936

Mounting bolt

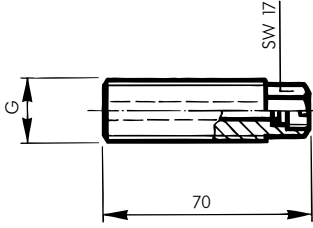

† see page 49 for plug & seal

*Available on 2 week delivery

| G | Code | £ | SP | g | | | | | | | | | | | | | | |
|-------|-------------|------|----|-----|--|--|--|--|--|--|--|--|--|--|--|--|--|--|
| *1/2† | 760 853 291 | 6.20 | 5 | 140 | | | | | | | | | | | | | | |

3937

Wall outlet plug, male

for protecting outlets from site debris during construction

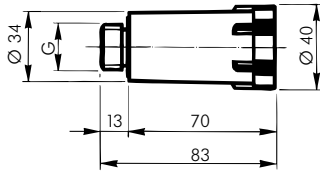

† see page 49 for plug & seal

*Available on 2 week delivery

| G | Code | £ | SP | g | | | | | | | | | | | | | | |
|-------|-------------|------|----|----|--|--|--|--|--|--|--|--|--|--|--|--|--|--|
| *1/2† | 760 853 297 | 4.08 | 10 | 98 | | | | | | | | | | | | | | |

3938

Wall outlet sleeve, female

for protecting outlets from site debris during construction

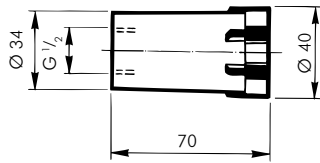

*Available on 2 week delivery

| G | Code | £ | SP | g | | | | | | | | | | | | | | |
|------|-------------|------|----|----|--|--|--|--|--|--|--|--|--|--|--|--|--|--|
| *1/2 | 760 853 298 | 3.37 | 10 | 51 | | | | | | | | | | | | | | |

Pipe supports and brackets

3913

Pipe clip, plastic

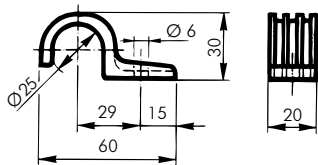

| d | Code | £ | SP | g | | | | | | | | | | | | | | |
|----|-------------|------|----|---|--|--|--|--|--|--|--|--|--|--|--|--|--|--|
| 16 | 760 853 627 | 0.18 | 50 | 6 | | | | | | | | | | | | | | |

Fixed point design

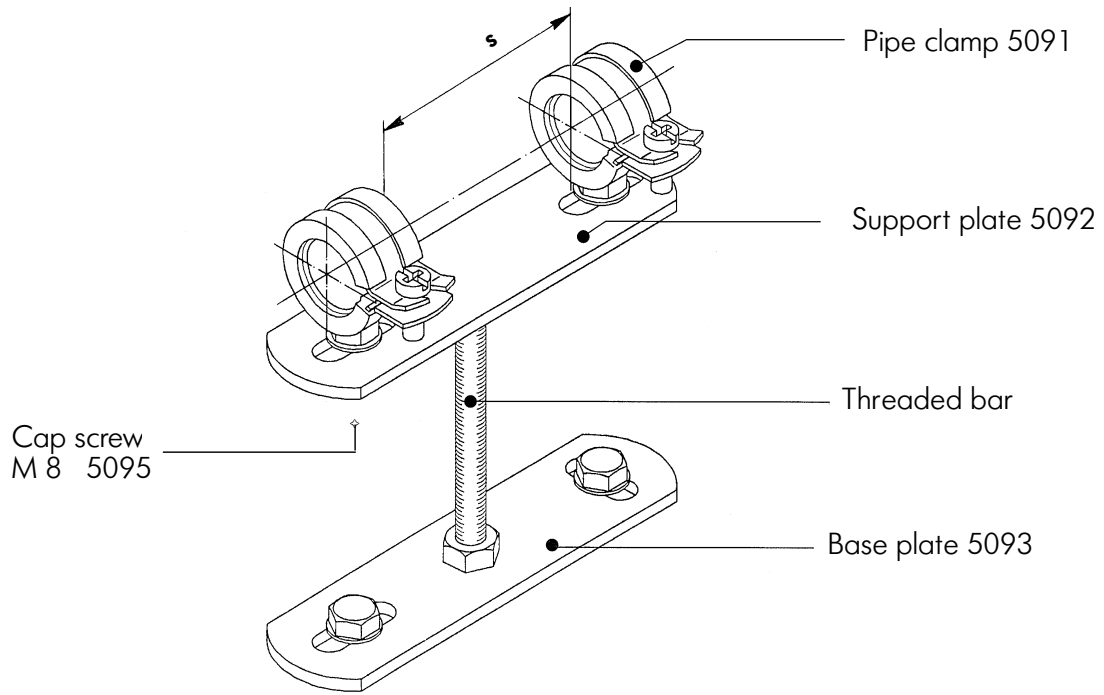

| Support plate No cat. | 1 | 2 | 3 | 4 |
|--------------------------------------|---------|---------|----------|-----------|
| Distance between pipe clamps « s » | 33 – 63 | 64 – 94 | 97 – 125 | 132 – 162 |

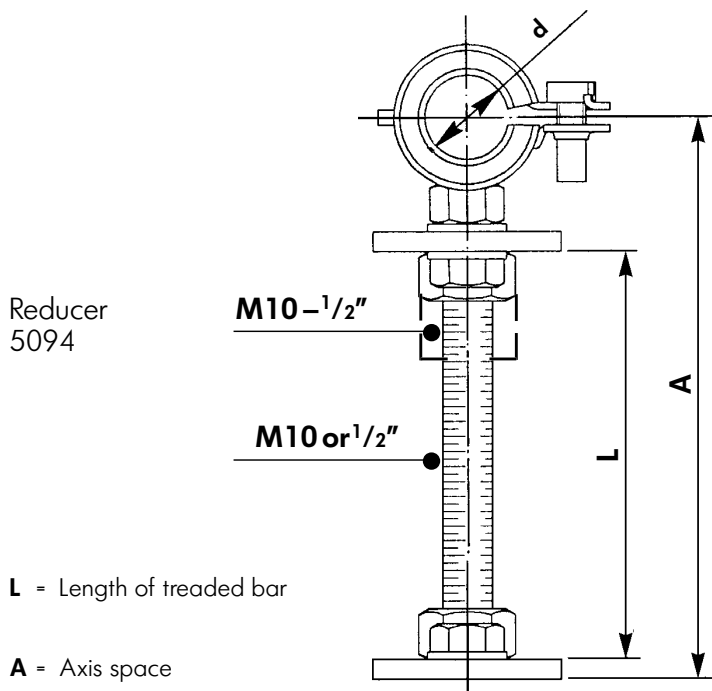

$$L = A - x$$

| Threaded bar | x | | |
|-------------------------|-------|---------|----|
| | $M10$ | $1/2''$ | |
| Pipe clamp diameter d | 16 | 27 | 49 |
| | 20 | 31 | 53 |
| | 25 | 33 | 55 |
| | 32 | 38 | 60 |
| | 40 | 42 | 64 |
| | 50 | 46 | 68 |
| | 63 | 53 | 75 |
| | 75 | 60 | 82 |

5091

Pipe clamp

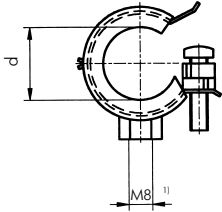

¹⁾ d 90 and d 110 = M10

*Available on 2 week delivery

| d | Code | £ | SP | g |
|------|-------------|------|----|-----|
| *16 | 761 066 296 | 0.95 | 50 | 40 |
| *20 | 761 066 297 | 1.04 | 50 | 51 |
| *25 | 761 066 298 | 1.09 | 50 | 55 |
| *32 | 761 066 299 | 1.19 | 50 | 60 |
| *40 | 761 066 300 | 1.42 | 50 | 81 |
| *50 | 761 066 301 | 1.53 | 50 | 91 |
| *63 | 761 066 302 | 2.25 | 50 | 132 |
| *75 | 761 066 303 | 2.39 | 50 | 152 |
| *90 | 761 066 304 | 2.87 | 25 | 191 |
| *110 | 761 066 305 | 3.08 | 25 | 232 |

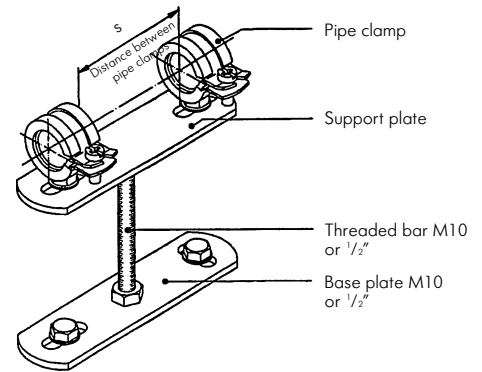

5092

Support plate for fixing point

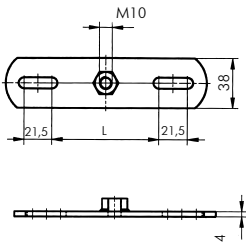

*Available on 2 week delivery

| Size | Code | £ | SP | g | L | s |
|------|--------------|------|----|-----|-----|---------|
| 1 | *761 066 731 | 2.75 | 10 | 135 | 44 | 33-63 |
| 2 | *761 066 732 | 2.87 | 10 | 170 | 75 | 64-94 |
| 3 | *761 066 733 | 3.01 | 10 | 211 | 106 | 97-125 |
| 4 | *761 066 734 | 3.19 | 10 | 253 | 143 | 132-162 |

5093

Base plate

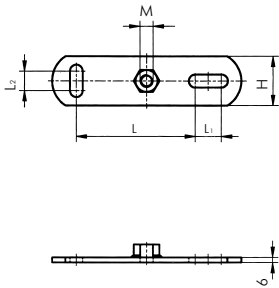

| Code | £ | SP | g | M | H | L | L ₁ | L ₂ | b |
|---------------|------|----|-----|-------|----|----|----------------|----------------|---|
| *761 066 741 | 0.98 | 50 | 159 | M8 | 25 | 47 | 6,5 | 6,5 | 3 |
| *761 066 735† | 1.04 | 50 | 170 | M10 | 38 | 91 | 20 | 20 | 4 |
| *761 066 311† | 2.01 | 20 | 181 | G 1/2 | 38 | 91 | 20 | 20 | 4 |

*Available on 2 week delivery † for fixing point

5094

Reducer

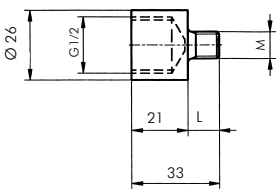

| M-G | Code | £ | SP | g | L |
|-----------|-------------|------|----|----|----|
| *M8-G1/2 | 761 066 318 | 2.39 | 20 | 55 | 10 |
| *M10-G1/2 | 761 066 306 | 2.39 | 20 | 57 | 12 |

*Available on 2 week delivery

5095

Cap screw

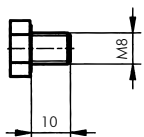

*Available on 2 week delivery

| Code | £ | SP | g |
|-------------|------|-----|---|
| 761 066 307 | 0.12 | 100 | 9 |

3915

Double pipe clip, metal

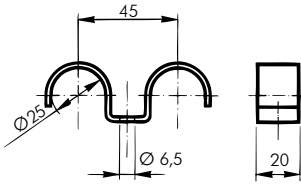

| d | Code | £ | SP | g | | | | | | | | | | |
|----|-------------|------|----|----|--|--|--|--|--|--|--|--|--|--|
| 16 | 760 853 628 | 0.41 | 50 | 44 | | | | | | | | | | |

3920

Pipe clip, metal

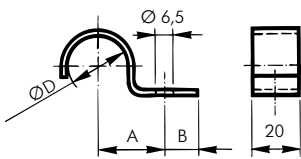

| d | Code | £ | SP | g | | | Ø D | A | B | | | | | |
|-----------|-------------|------|----|----|--|--|-----|----|----|--|--|--|--|--|
| 16 | 760 853 254 | 0.24 | 50 | 27 | | | 25 | 29 | 15 | | | | | |
| 20 | 760 853 567 | 0.29 | 50 | 30 | | | 30 | 32 | 15 | | | | | |
| 25 | 760 854 951 | 0.41 | 50 | 42 | | | 34 | 35 | 15 | | | | | |
| Isolation | 760 853 839 | 0.47 | 50 | 42 | | | 40 | 32 | 13 | | | | | |

Spare Parts

3800

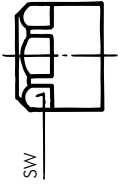

*Available on 2 week delivery

Union nut for compression fittings

| d | Code | £ | SP | g | | | SW | | | | | | | | |
|-----|-------------|------|----|----|--|--|----|--|--|--|--|--|--|--|--|
| *16 | 760 853 018 | 1.06 | 5 | 32 | | | 24 | | | | | | | | |
| *20 | 760 853 071 | 1.74 | 2 | 43 | | | 27 | | | | | | | | |

3801



*Available on 2 week delivery

Clamping ring for compression fittings

| d | Code | £ | SP | g | | | | | | | | | | | |
|-----|-------------|------|----|----|--|--|--|--|--|--|--|--|--|--|--|
| *16 | 760 853 019 | 1.01 | 5 | 12 | | | | | | | | | | | |
| *20 | 760 853 072 | 1.56 | 2 | 20 | | | | | | | | | | | |

3211

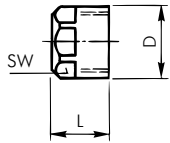

*Available on 2 week delivery

Cap including seal, for blanking of compression fittings

| d | Code | £ | SP | g | | | Ø D | L | SW | | | | | | |
|-----|-------------|------|----|----|--|--|-----|----|----|--|--|--|--|--|--|
| *16 | 760 853 110 | 2.07 | 5 | 51 | | | 27 | 26 | 24 | | | | | | |
| *20 | 760 853 150 | 2.78 | 5 | 94 | | | 32 | 33 | 27 | | | | | | |

3803

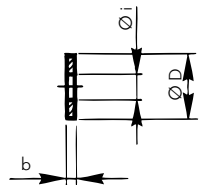

*Available on 2 week delivery

Seal for cap cat. no. 3211 above

| | Code | £ | SP | g | | | Ø D | Ø i | b | | | | | | |
|--------|-------------|------|----|---|--|--|------|-----|---|--|--|--|--|--|--|
| *16/20 | 760 853 021 | 0.83 | 5 | 1 | | | 14,5 | 6 | 3 | | | | | | |

3212

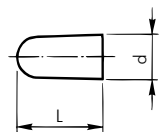

*Available on 2 week delivery

Cap PB temporary cap for PB pipes

| d | Code | £ | SP | g | | | L | | | | | | | | |
|-----|-------------|------|----|---|--|--|----|--|--|--|--|--|--|--|--|
| *16 | 760 853 790 | 0.41 | 10 | 4 | | | 35 | | | | | | | | |

3804

Screw for backing plates

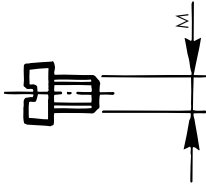

| M | Code | £ | SP | | | | | | | | | | | | |
|------|-------------|------|-----|--|--|--|--|--|--|--|--|--|--|--|--|
| 6x 8 | 760 853 022 | 0.21 | 100 | | | | | | | | | | | | |

3805

Screw for outlets

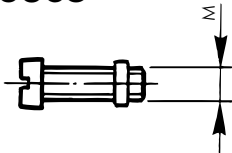

| M | Code | £ | SP | | | | | | | | | | | | |
|-------|-------------|------|----|--|--|--|--|--|--|--|--|--|--|--|--|
| *6x20 | 760 853 023 | 0.29 | 10 | | | | | | | | | | | | |

*Available on 2 week delivery

3831

Plug for mounting bolt item 3936, page 39

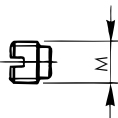

| M | Code | £ | SP | g | | | | | | | | | | | |
|-----|-------------|------|----|---|--|--|--|--|--|--|--|--|--|--|--|
| *12 | 760 854 918 | 1.60 | 10 | 8 | | | | | | | | | | | |

*Available on 2 week delivery

3832

Seal for mounting bolt plug item 3831 above

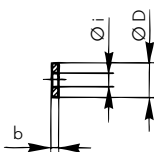

| | Code | £ | SP | g | | | $\varnothing D$ | $\varnothing i$ | b | | | | | | |
|---|-------------|------|----|---|--|--|-----------------|-----------------|---|--|--|--|--|--|--|
| * | 760 854 045 | 0.65 | 10 | 1 | | | 9,5 | 4 | 2 | | | | | | |

*Available on 2 week delivery

3827

Seal for wall outlet plug

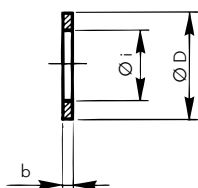

| | Code | £ | SP | g | | | $\varnothing D$ | $\varnothing i$ | b | | | | | | |
|---|-------------|------|----|---|--|--|-----------------|-----------------|---|--|--|--|--|--|--|
| * | 760 853 175 | 0.71 | 10 | 2 | | | 29 | 19 | 3 | | | | | | |

*Available on 2 week delivery